

TC6-CSN type TOYOCONNECTOR® Handling Manual

Be sure to read this manual before using the connector.

Warning: A potentially hazardous situation which could result in death or serious injury.

This is an instruction for the correct use of TOYOCONNECTOR. Like the hoses itself, there are also limitations for the use of TOYOCONNECTOR. Please observe the following safety precautions fully. Failure to observe these could result in injury or property damage.

The TOYOCONNECTOR TC6-CSN coupler (Hereinafter referred to as " coupling ") is a coupling designed for exclusive use with the HYBRID TOYOFOODS-N HOSE.

Using this coupler with hoses other than the HYBRID TOYOFOODS-N HOSE could result in problems such as leakage or disconnection.

- (Note) 1. In order to use this coupler safely, please make sure to follow the handling precautions and the fitting method of the coupling described in this instruction manual. Failing to comply with these could lead to problems occurring.
 2. At the time of purchase, a silicone gasket (white) is attached. When using mineral oil or animal and vegetable oil, replace this gasket with the supplied NBR gasket (black). Also, when using fluids to which neither silicone nor NBR has resistance, please purchase other materials separately.

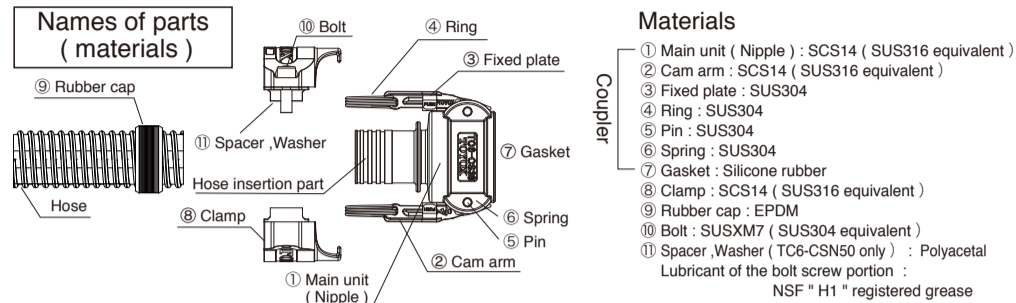

Materials

- ① Main unit (Nipple) : SCS14 (SUS316 equivalent)
 ② Cam arm : SCS14 (SUS316 equivalent)
 ③ Fixed plate : SUS304
 ④ Ring : SUS304
 ⑤ Pin : SUS304
 ⑥ Spring : SUS304
 ⑦ Gasket : Silicone rubber
 ⑧ Clamp : SCS14 (SUS316 equivalent)
 ⑨ Rubber cap : EPDM
 ⑩ Bolt : SUSXM7 (SUS304 equivalent)
 ⑪ Spacer, Washer (TC6-CSN50 only) : Polyacetal
 Lubricant of the bolt screw portion : NSF " H1 " registered grease

Names of parts (materials)

- Before fitting**
- ⚠ **Note** This coupling should not be disassembled for cleaning on a daily basis.
 - ⚠ **Warning** When replacing a hose or disassembling a coupling, wait until the coupling is cooled down to the room temperature. If not, you may get burned or the coupling may get damaged.
1. When cutting a hose, please make sure that the edge face of the hose will become square-on.
 2. If there are any loose strings or hard wires coming out from the end of the hose, be sure to remove such with nippers, etc. Take care such that the hose scraps, loose strings, or hard wires do not enter the hose.
 3. Be sure to have a sufficient hose length so as not to apply a hose bending stress around a coupling.
 4. Make sure that the hose is inserted completely into the root of hose insertion part.
 5. ⚠ **Warning** When inserting hoses into TOYOCONNECTOR, never put grease on the surface of the hose insertion part. It would be a cause of hose being pulled out.
 6. Fasten the clamp after confirming the direction of each component.
 7. Be careful of injuries caused by tools slipping during the fastening process.
 8. Be sure to use a " hex wrench " that is at least 180mm long to fasten the bolts (at least 200mm long for TC6-CSN50). Fasten the 2 bolts evenly while alternating and fasten these until there are no gaps. When used in a state where there are gaps, trouble due to leaked fluids and detached hoses will occur. Refrain from using an impact driver when fastening the bolts. Doing so may damage the screws of the clamp.
 9. ⚠ **Note** Complete fastening cannot be achieved with uneven fastening.
 10. ⚠ **Note** A lubricant (Extreme pressure grease) registered with NSF " H1 " approved for use in areas that may accidentally come into contact with food " is applied to the screw portion of the clamp of TC6-CSN.
 11. ⚠ **Note** When fastening the unit, there rarely may be cases when resin or metal dust (or stringy shavings) is generated. Be sure to remove such prior to use.
 12. Avoid adhering incompatible chemicals to rubber parts of coupling.

Notes for connecting a coupler

1. Select the main unit and gasket materials suitable for the fluid used.
2. Chemicals which are dangerous when permeating (active gases) should not be used in gaseous form.
3. Use the products within their intended working pressure range.
4. Do not apply external force (e.g. impact) to the body and cam arm. This may cause damage.
5. Avoid pulling or dragging the hoses on the floor. Doing so may cause the cam arms to catch against an object and unlock.
6. Avoid applying loads on joints. This may cause fluid spills.

Notes for use

1. TOYOCONNECTOR TC6-CSN is a hose coupling designed for exclusive use with the HYBRID TOYOFOODS-N HOSE. If connected with hoses from other manufacturers or incompatible hoses, performance may not be fully demonstrated or maintained, and no guarantee can be provided in such case. (Product number of compatible hose : HTF-N)
2. Use TOYOCONNECTOR with in the operating temperature and pressure ranges of the applicable hose.
3. Hoses usable under negative pressures may not be applicable depending on applications and conditions (temperature, movement, etc.).
4. Do not use a hose that is extremely bent near a coupling. The bend radius of a hose should be larger than its minimum bend radius.
5. ⚠ **Warning** Do not assemble or disassemble the coupling while fluid is in the hose because the hose may become loose and the liquid will leak.
6. Do not use the coupling where there is vibration or shock. It may cause the coupling to break or the hose to become detached.
7. Perform a start-up inspection and routine inspections thereafter to ensure that the hose has not come away from the coupling, no fluid is leaking, and the bolt is tight while in use.
8. Do not allow anything other than the inner surface of the couplings or hose to come in contact with fluids (food, etc.), because the fluids may permeate the hose reinforcement layer or remain inside the couplings, and bacteria may propagate (attach to the parts) or the hose may deteriorate. Also, dust, hose fragments (reinforcement material) and ink adhering to the outer surface may be mixed in.
9. ⚠ **Warning** Never use TC6-CSN for the below applications. Couplings may be damaged, hoses may rupture or become loose.
 - For piping such as electromagnetic valve piping, which would put impact pressure on the piping
 - Where vibration or impact will be applied to the coupling
 - Purposes that exceed the maximum temperature of use
 - Where constant tensile stress may be applied to the hoses
 - In a way that may cause static buildup (There is a danger of electrical shocks.)
10. Before using TC6-CSN make certain to sterilize and disinfect inside the hoses. (The hoses do not go through sterilization procedures before shipping.)
11. When cleaning TC6-CSN, do not rub their surfaces with a hard brush or other things because doing so may damage the surfaces, and bacteria may propagate.
12. Please store the coupling at low temperature and humidity. Ensure the coupling is sealed for protection against dust and foreign matter.
13. Products should be disposed of in accordance with the requirements of the local region.
14. Use dust plugs and dust caps to prevent accumulating dust and damage or deformation of the sealing surface.
15. Remove residual fluid from the main unit after using the couplings.

Notes for gaskets

1. Before using the coupler, check to confirm that the gasket fits into the groove of the coupler main unit. (See figure to the right)
2. Foreign matter adhering to the gasket seat can make it hard to close the cam arms and may lead to spills. Inspect and remove any foreign matter.
3. Because gaskets using Teflon (PTFE) solids or Teflon lack elasticity, they may leak depending on conditions of use.
4. Assess the force required to close the cam arms when connecting or disconnecting Coupler. If the force required is too low, the gasket seal may be compromised. In this case, we recommend replacing the gasket.
 - * If closing the cam arms feels too easy even after replacing the gasket, the main unit may be damaged. If so, replace the main unit.

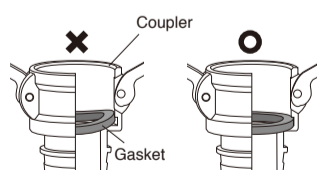

Notes on inspection

1. Startup inspections: Before starting operations, check to confirm that the couplings are free of abnormalities and that the cam arms are fully closed.
2. Regular inspection: During periods in use, be sure to perform regular inspections.

What to do if an abnormality is found

If you observe signs of abnormalities like those below during startup inspections or periodic inspections, stop using the product immediately. Replace with a new product.

1. The main unit or any of the components show large scratches, cracks, deformation, or projecting pins. (The service life of the main unit, cam arms, and gaskets depends on materials and usage conditions. We recommend replacement at periodic intervals.)
2. Closing the cam arms feels too easy when connecting or disconnecting Coupler.

7. We recommend using couplers and adapters made of the same material when connecting couplings. Using couplers and adapters made of different materials may lead to corrosion (electrical corrosion).
8. Dismantle the coupler connection only after confirming that there is no residual pressure or materials.
9. To avoid burns during use with high-temperature fluids, avoid direct contact with the main unit.
10. Wear gloves and safety shoes to prevent injury during installation and operation.
11. Position the coupler on the lower side of adaptor when installing fittings.
12. High fluid flow rates may result in cavitation that abrades or damages the inner surface of the coupler. Perform inspections at the appropriate intervals.
13. When connecting coupler, chip dust may transpire due to cam arm tightening. Remove chip dust before use.

How to attach a hose

1. Loosen the bolt and remove the clamp from the nipple.

TOYOCONNECTOR Code	Size of hexagonal bolt hole
TC6-CSN 38	6mm
TC6-CSN 50	8mm

2. Fix the main unit (nipple) coupler onto the piping to which it will be attached. Next, while adjusting the length of the hose, cut the end of the hose vertically. Take care such that the tensile element of the hose is not applied.

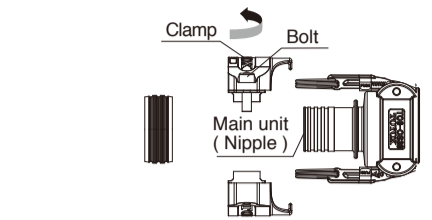

3. Remove the coupler from the piping and perform the assembly. Place the rubber cap over the hose. By marking a line in advance on the hose according to the " Appropriate Rubber Cap Insertion Volume " table on the below, it will be possible to appropriately align the position of the rubber cap.

Appropriate Rubber Cap Insertion Volume

TOYOCONNECTOR Code	mm
TC6-CSN 38	45
TC6-CSN 50	55

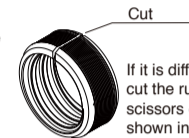

4. Insert the hose equipped with the rubber cap into the base of the hose opening of the hose insertion part.
5. Provisionally assemble the clamp in line with the grooves on the nipple.
 - * If the spacer has fallen off of the bolt, provisionally assemble the clamp after attaching the spacer onto the bolt. (Figure 1)

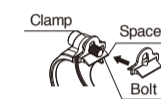
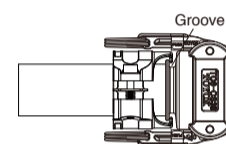
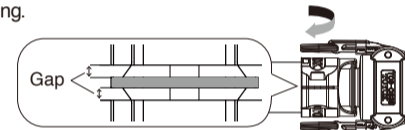

Figure 1

6. Fasten the 2 bolts evenly while alternating and fasten these until there are no gaps. If there is any gap between the clamp components and you cannot fasten the clamp fully, leave the unit for a while and tighten the clamp again until there is no gap left.
 - ⚠ **Note** Complete fastening cannot be achieved with uneven fastening.
 - ⚠ **Note** Be sure to use a " hex wrench " that is at least 180mm long to fasten the bolts (at least 200mm long for TC6-CSN50).
 - ⚠ **Note** When fastening the unit, there rarely may be cases when resin or metal dust (or stringy shavings) is generated. Be sure to remove such prior to use.



Notes for Connector Reuse and Hose Replacement

1. When reusing a TOYOCONNECTOR product, make sure that each of its components are not damaged prior to use. Be sure to replace the rubber cap. Please be sure to fasten the bolts after applying a commercially available lubricant (Extreme pressure grease) to the screw portions of the bolts and the clamp. Please use lubricant (Extreme pressure grease) registered as NSF " H1 " which is "permitted at places where incidental contact with food may occur."
2. Before replacing a hose, always make sure to remove the fluid and dirt on the coupling surface. Fluid and dirt remaining on coupling may possibly cause fluid leakage and hose loosening.
3. When reusing a TOYOCONNECTOR product, please make sure to use a brand-new hose.
4. Although this may differ depending on conditions of use, replace the unit with components or a new clamp set after it has been removed approximately 5 times.
5. Do not hit the coupling with a hammer or some other tools.

Warning

1. The material used for the TOYOCONNECTOR flow pass (inner surface) is SCS16 (SUS316L equivalent). Phenomena such as corrosion or fluid leaks may occur depending on the type of fluid. Before use, be sure to check data (refer to data on chemical resistance in the catalog or on the homepage). Please also make similar checks for fluid contact with the outer surface of coupling.
2. Do not use hoses when they are twisted. Partially twisted hoses are also a danger as they may cause internal structural damage leading to a " Burst ". Follow the examples below to take preventative measures.

Example 1) Twisted hose while piping

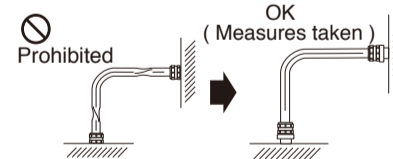

Example 2) Twist when bent

